

BOURDON
The Original by Baumer



Main Features

- High over pressure resistant
- Excellent repeatability
- Fix dead band for control and alarm
- Dead band adjustment for regulation
- Intrinsic safety Hazardous area 0, 1, 2

Applications

- Power generation safety equipment
- Pressurized chambers control
- Liquid level control

Technical Data

Pressure range	-50 mbar ... 0 to 0 ... 2500 mbar	Electrical connection	Terminal block with plastic cable gland for Ø 7 to 10.5 mm
Temperature	Process : -15 ... +150°C Ambient : -25 ... +70°C (T5) Storage : -30 ... +55°C (T6) -40 ... +70°C	Electrical function	See ordering code details on page 5
Repeatability	± 1% F.S. @ constant pressure cycle	Adjustment	2 external adjustment screws on top of the case for set point and dead band
CE conformity	Low Voltage Directive LVD 2006/95/EC Pressure Equipment Directive PED 97/23/EC ATEX Directive 94/9/EC	ATEX	<u>Type examination certificate</u> LCIE 03 ATEX 6123X EN 60079-0 : 2009 EN 60079-11 : 2012
Protection rating	IP 66 (EN 60529)	Marking	CE 0081 Ex I M 1 Ex ia I Ma Ex II 1 G Ex ia IIC T6 or T5 Ga
Process connection	Stainless steel 1.4404 (316L)	Electrical data	U _{max} = 28 Vdc I _{max} = 120 mA P _{max} = 0.84 W C _i = Negligible ; L _i = Negligible
Sensing element	Flanges : Stainless steel 1.4404 (316L) Diaphragm : Viton®		
Scale	Internal. Accuracy on reading ± 5% FS		
Cover	Zamak blue painted Captive stainless steel screws		
Case	Black Zamak		
Mounting	Wall mounting bracket		
Ground connection	Via internal terminal block		

Options

Customer specific set point adjustment	Code SETP
Oxygen application	Code 0765
Mounting on 2" pipe	Code 0407
Electrical connection : stainless steel connector (Souriau)	Code 2298
Mobile plug for stainless steel connector (Souriau)	Code 2249
Stainless steel tag plate and wire	Code 9941
Lead seal of the adjustment screws	Code 8990

Principle

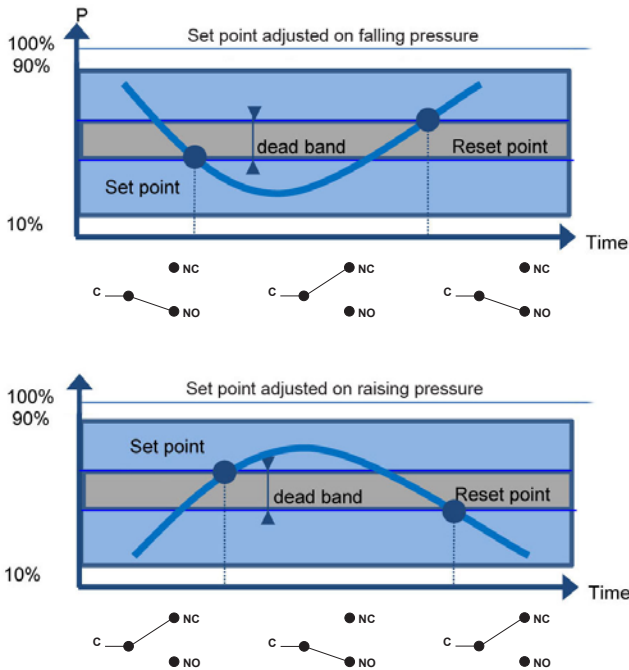

A vapour filled sensing element actuates a microswitch by means of a lever. The set point and the dead band are set by springs mounted in opposition

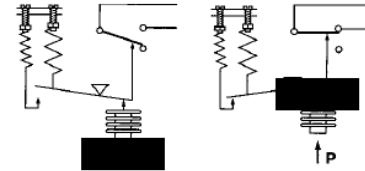

Set point and reset point must be between 10% and 90% of the selected scale.

Standard factory adjustment

Setpoint at 50% of the scale on falling pressure

Customer specific factory adjustment (option SETP)

The following specifications have to be given with the order:

- Setpoint value
- Adjustment on falling or raising pressure
- Dead band value when using an adjustable dead band switch

Electrical connections

1 SPDT

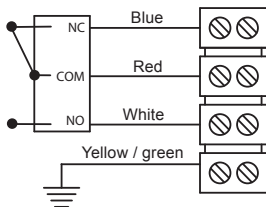

2 SPDT

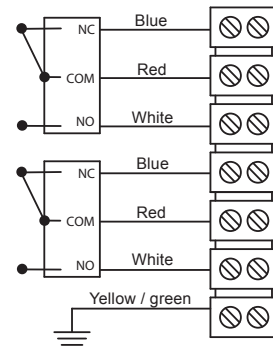

Hazardous area
Zone 0, 1, 2

Certified safety
barrier

Non hazardous
area

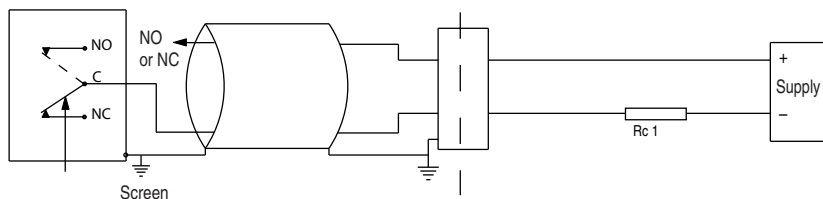

For max. ambient temperature according to temperature classes T5 and T6 refer to technical data on page 1.
The installation must be made in an intrinsically safe circuit whose certified electrical safety parameters do not exceed any of the values U_{max} , I_{max} and P_{max} given in the electrical data on page 1.

All necessary measures must be taken by the user, to avoid the calorific transfer from the fluid to the apparatus head increasing the head's temperature to such that it reaches the self-ignition temperature of the gas in which it is used.

Micro switches characteristics

Switch code	N (T)	M (K)	C (W)	S
Type	Tropicalized	Gold contact	Hermetic	Ultrasensitive Gold contact
6 Vdc	0.1 ... 0.12 A	10 ... 50 mA	5 ... 120 mA	10 ... 50 mA
12 Vdc	N/A	10 ... 50 mA	5 ... 66 mA	10 ... 50 mA
24 Vdc	N/A	10 ... 33 mA	5 ... 33 mA	10 ... 33 mA
30 Vdc	N/A	N/A	N/A	N/A
48 Vdc	N/A	N/A	N/A	N/A
110 Vdc	N/A	N/A	N/A	N/A
220 Vdc	N/A	N/A	N/A	N/A
115 Vac	N/A	N/A	N/A	N/A
250 Vac	N/A	N/A	N/A	N/A
Dielectric rigidity between contacts and ground	2000 V	2000 V	1500 V	2000 V

Adjustable ranges

Scale	P. Max accidental	Code	Micro-switch dead band ¹⁾							
			Adjustable dead band				Fixed dead band			
			N (T*)		M (K*)		C (W*)		S	
			10%	90%	10%	90%	10%	90%	10%	90%
mbar	bar									
-50 ... 0	10	101	2 - 25	2.5 - 25	6.5 - 25	7.5 - 25	1.4	1.7		
-2 ... 10	10	102	1 - 10	1 - 10	4.5 - 10	4.5 - 10	1	1.1		
-5 ... 50	10	103	1 - 20	2 - 20	4.5 - 20	5 - 20	1	1.1		
-8 ... 100	10	104	1.5 - 25	2.5 - 25	5 - 25	10 - 25	1.2	1.4		
-200 ... 0	50	151	12 - 80	20 - 80	25 - 80	40 - 80	7	11		
0 ... 200	50	152	15 - 80	25 - 80	30 - 80	45 - 80	8	11		
0 ... 400	50	153	17 - 150	30 - 150	35 - 150	50 - 150	9.2	15.4		
0 ... 1000	50	154	22 - 150	35 - 150	45 - 150	60 - 150	14	19.5		
0 ... 700	100	171**	20 - 350	40 - 350	40 - 350	70 - 350	16	25		
0 ... 1500	100	172**	20 - 350	60 - 350	40 - 350	100 - 350	16	25		
0 ... 2500	100	173**	25 - 350	90 - 350	50 - 350	160 - 350	21	31		

(*) For version with 2 microswitches lower values of the dead band must be multiplied x 1.5

(**) G1/4 female only

¹⁾ The value of the dead band is depending on the value of the set point.

This table contains the dead band values for set point adjustment at 10% and 90% of the selected scale. For adjustable dead band the lower value corresponds to the dead band spring totally released and the higher corresponds to the dead band spring fully tensed. For other set points the dead band value can be calculated by linear interpolation between the values at 10% and 90%.

Dimensions (mm)

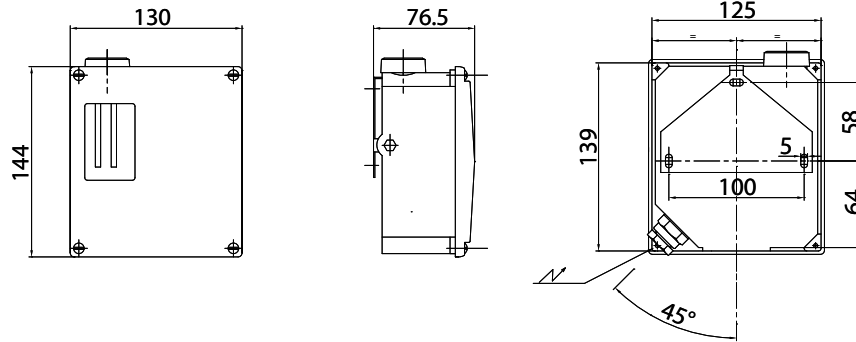

Pressure range code : 101 - 102 - 103 - 104
Weight : 10 kg

Pressure range code : 151 - 152 - 153 - 154
Weight : 6.4 kg

Pressure range code : 171 - 172 - 173
Weight : 7 kg

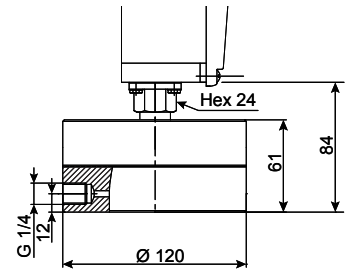
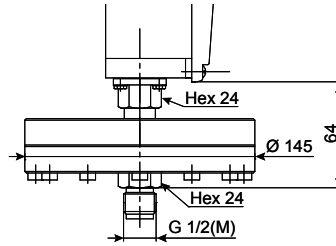
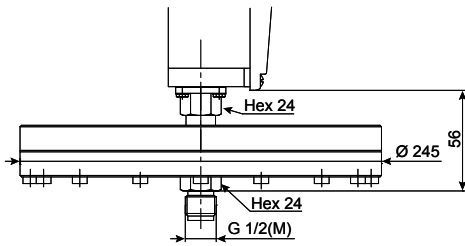

Ordering details RPPY4

	RP	PY	-	4		.	xxx	/
Model								
Industrial pressure switch	RP							
Approvals								
ATEX intrinsic safety		PY						
Sensing element								
Diaphragm (Viton®), high overpressure resistance				4				
Type of micro switches								
					Deadband			
1 SPDT hermetically changeover switch					Adjustable			C
2 SPDT hermetically changeover switch					Adjustable			W
1 SPDT gold contact changeover switch					Adjustable			M
2 SPDT gold contact changeover switch					Adjustable			K
1 SPDT tropicalized changeover switch					Adjustable			N
2 SPDT tropicalized changeover switch					Adjustable			T
1 SPDT ultrasensitive gold contact changeover switch					Fix			S
Process connection								
G 1/4 female (only pressure ranges 171, 172, 173)								H
G 1/2 male (standard)								3
1/2 NPT male								6
1/4 NPT female								8
Pressure range (mbar)								
					Pressure range (kPa)			
-50 ... 0					-5 ... 0			101
-2 ... 10					-0.2 ... 1			102
-5 ... 50					-0.5 ... 5			103
-8 ... 100					-0.8 ... 10			104
-200 ... 0					-20 ... 0			151
0 ... 200					0 ... 20			152
0 ... 400					0 ... 40			153
0 ... 1000					0 ... 100			154
0 ... 700					0 ... 70			171
0 ... 1500					0 ... 150			172
0 ... 2500					0 ... 250			173
								Process connection G1/4 female
								Process connection G1/4 female
								Process connection G1/4 female
Options to be added behind the / (see example below)								

Ordering example with options

	RP	PY	-	4	C	3	.	101	/	0407	-	9941
Industrial pressure switch	RP											
With ATEX approval intrinsic safety		PY										
Diaphragm Viton®				4								
1 SPDT hermetically changeover switch					C							
Process connection G 1/2 male						3						
Pressure range -50 ... 0 mbar							.	101				
Option : Mounting on 2" pipe									/	0407		
Option : Stainless steel tag plate and wire											-	9941